



***Rubena***

**RUBBER-TEXTILE  
PRODUCTS**





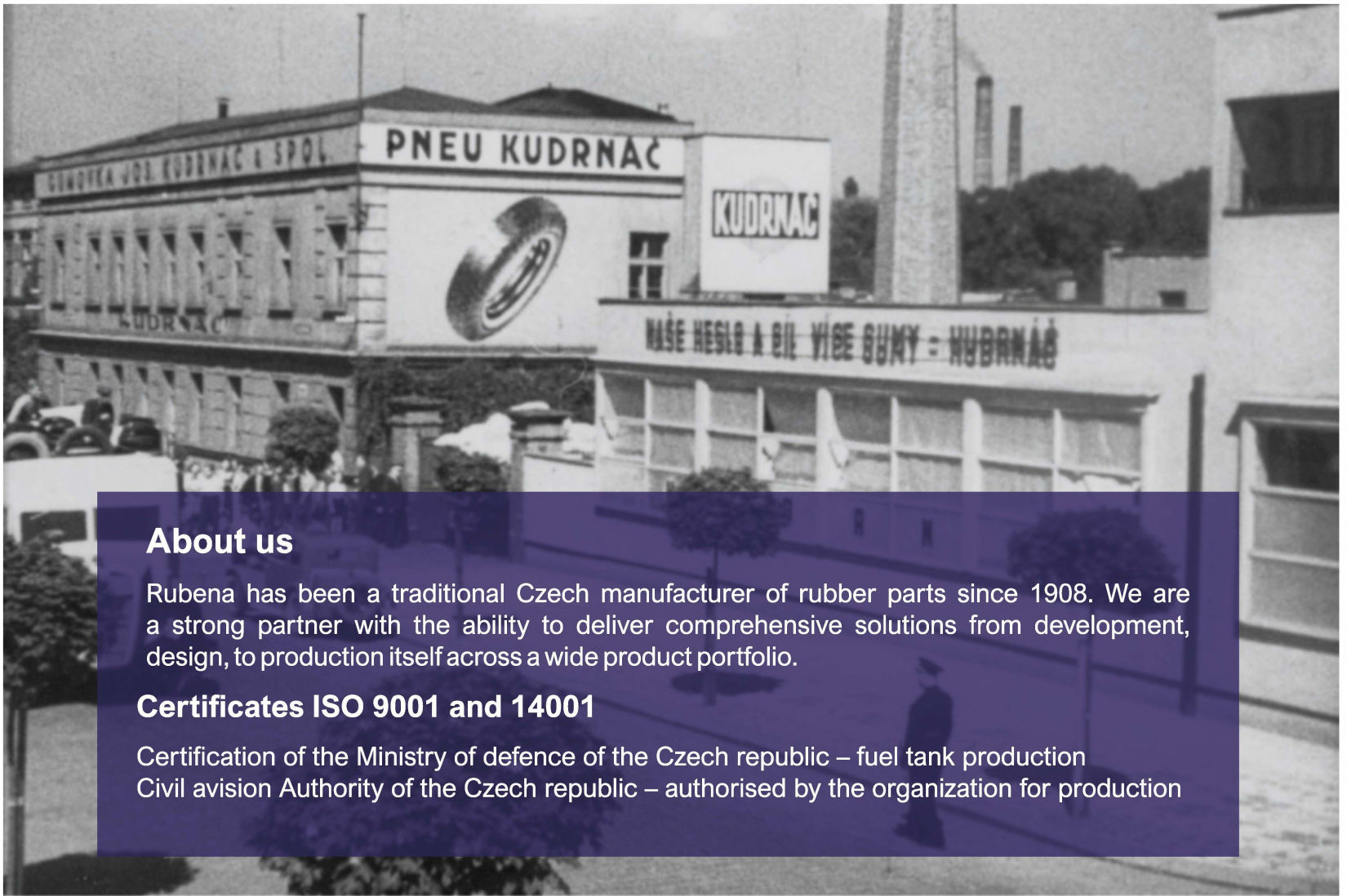

## About us

Rubena has been a traditional Czech manufacturer of rubber parts since 1908. We are a strong partner with the ability to deliver comprehensive solutions from development, design, to production itself across a wide product portfolio.

### Certificates ISO 9001 and 14001

Certification of the Ministry of defence of the Czech republic – fuel tank production  
Civil aviation Authority of the Czech republic – authorised by the organization for production

## History



1908	Josef Kudrnáč starts manufacturing lubricants, asbestos-rubber products and sealants.
1923	Production of technical rubber.
1929	Production of bicycle tyres and inner tubes.
1931	Production of first Czech tyres and inner tubes for passenger cars.
1934	Tomáš Baťa starts V-belt production in Zlín.
1948	The company adopts the new name Rubena. The Barum brand is created.
1996	Rubena a.s., Náchod becomes a part of Česká Gumárenská Společnost with its headquarters in Prague
2000	Rubena Náchod and Gumokov Hradec Králové create the joint venture Rubena a.s., Hradec Králové.
2004	Rubena a.s., Hradec Králové buys V-belt production from the company Mitas a.s. in Zlín.
2006	Subsidiary CGS Automotive de Mexico was founded.
2016	Rubena became part of the Trelleborg Group.
2021	Rubena become part of the Czech investment group KAPRAIN.



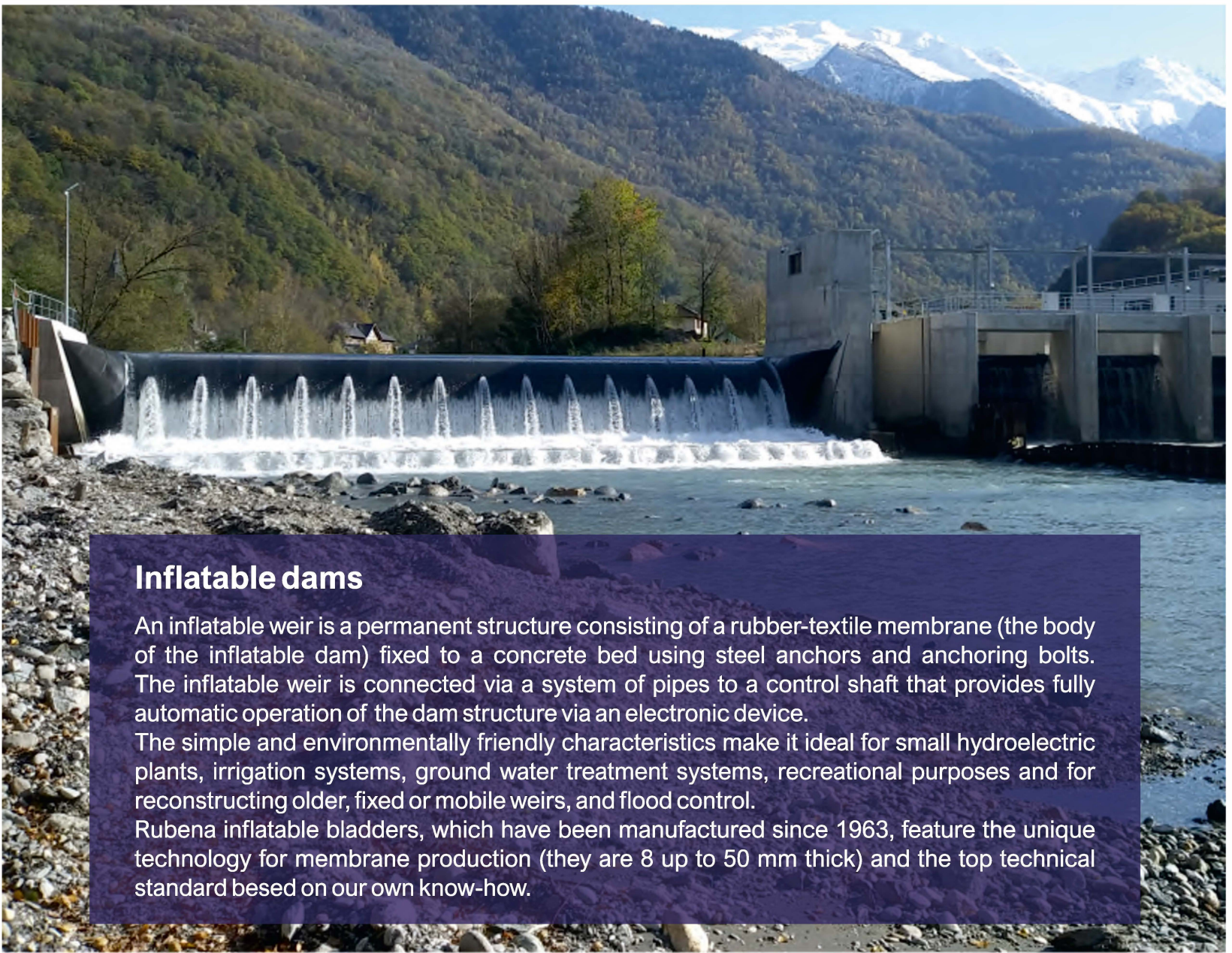

## Inflatable dams

An inflatable weir is a permanent structure consisting of a rubber-textile membrane (the body of the inflatable dam) fixed to a concrete bed using steel anchors and anchoring bolts. The inflatable weir is connected via a system of pipes to a control shaft that provides fully automatic operation of the dam structure via an electronic device.

The simple and environmentally friendly characteristics make it ideal for small hydroelectric plants, irrigation systems, ground water treatment systems, recreational purposes and for reconstructing older, fixed or mobile weirs, and flood control.

Rubena inflatable bladders, which have been manufactured since 1963, feature the unique technology for membrane production (they are 8 up to 50 mm thick) and the top technical standard based on our own know-how.



Low acquisition and operating costs



No negative environmental impact



Hundreds of successful installations



High resistance to vibrations during overflowing water, which can be increased with vulcanized baffles if required



Complete installation and service maintenance globally



Low maintenance lower structure and reconstruction of old fixed weirs or weirs with sluice or water gates



Low maintenance and operation costs



Waterfront pillars can be modified from the perpendicular to a tilt of 1:3, with the pillar axis not perpendicular to the longitudinal axis of the weir



Problem-free winter operation



Simple regulation of the upper level with an accuracy of  $\pm 2$  cm, even for flood flow rates up to the capacity of the dedicated opening



More than 30 years lifetime



Practically the only alternative for horizontally or vertically curved overflow edges





## Aircraft fuel tanks

Aircraft fuel tanks are specially designed rubber-textile bags fitted with anchoring bolts that attach them to the interior parts of the airframe and wings. Serving as fuel containers in an aircraft, these shaped tanks are made of rubber resistant to oil products. Filling and emptying are provided by metal flanges vulcanized onto the tank.



Quality products used for Czech ground attack aircrafts L-159 and other aircrafts L-39, L-410



Shape stability of the fuel filled space guaranteed



Maximum utilization of the aircraft interior



Excellent resistance to temperature differences



Easier assembly and servicing thanks to elasticity and good shaping



Suitable also for application in other machines (e.g. racing vehicles and other machines requiring light, variably-shaped fuel tanks)

## Membranes for heating systems

Standard membranes are rubber bags designed to equalize pressure during the dilatation of heating media in closed heating systems or waterworks. Flat bag membranes are used in heating pressure expansion vessels designed for use in drinking and service water systems (separating gas and water from each other) and are fitted with a necessary suspension fixing system.



Custom development of a blocking system shape, position and structure



Wide range (ca 700 types of 100 up to 25 000-litre volume)



Special compound for drinking water membranes



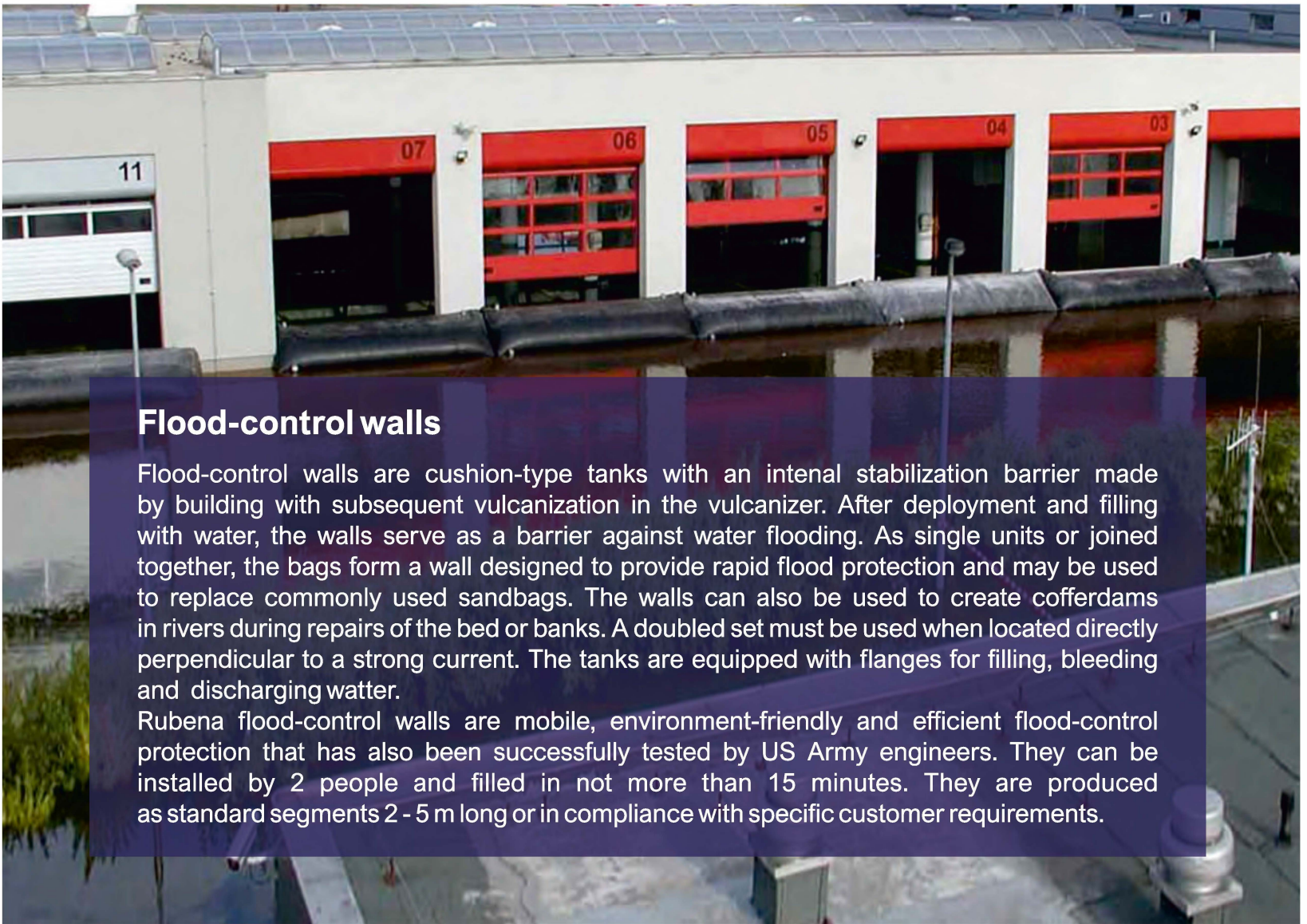

## Flood-control walls

Flood-control walls are cushion-type tanks with an internal stabilization barrier made by building with subsequent vulcanization in the vulcanizer. After deployment and filling with water, the walls serve as a barrier against water flooding. As single units or joined together, the bags form a wall designed to provide rapid flood protection and may be used to replace commonly used sandbags. The walls can also be used to create cofferdams in rivers during repairs of the bed or banks. A doubled set must be used when located directly perpendicular to a strong current. The tanks are equipped with flanges for filling, bleeding and discharging water.

Rubena flood-control walls are mobile, environment-friendly and efficient flood-control protection that has also been successfully tested by US Army engineers. They can be installed by 2 people and filled in not more than 15 minutes. They are produced as standard segments 2 - 5 m long or in compliance with specific customer requirements.



Mobile economical ecological and effective flood protection



Resistant to normal climatic conditions and chemical solutions in the long term



Easy handling and quick installation (2 people are enough for installation and 15 minutes for filling time)



Possible custom production according to specific customer requirements



No building readiness is required before use



It can be used as a service water tank, collecting bag for contaminated water or as an emergency collection bag



Can be filled with water from the river using conventional pumps or water from fire trucks hydrants

## Application

- Mobile flood-control wall.
- Emergency containment bag for chemical solutions.
- Reservoir for non-potable water.
- Elements for constructing swimming pools and decontamination stations.
- Elements for walkways in flood situations.
- Segments for diverting water flow during construction and other activities.
- Segments for creating temporary weirs on watercourses.
- They are suitable for collecting water contaminated with hazardous substances. Neutralization can be done directly inside the bag.



## Non-standard small series products

### Pressing bags

Pressing bags are rubber or rubber-textile cushion or flat-form, products. Pressing bag filling media are compressed air or a liquid, most often treated water. They are used to seal moulds during the product shaping process, for example for the automotive or ceramic industries, etc. The principle consists in inducing compression force in the bag using compressed air or a liquid, which produces the desired product shape. The bags are made from several types of rubber compounds according to their intended use and can be reinforced with textile fibres. The produced bags are up to 2.5 m wide and 13 m long. Short delivery time.

### Other pressing rubber and rubber-textile products

**Rubber-textile inflatable bags (of smaller dimensions)** - suitable for repairs of car body dents.

**Rubber-textile inflatable sleeves** - designed to shape winding in the production of electric motors.

**Silicon-textile flat pressing membranes** - used in the production of carpets.

**Pressing bags** - used in the food processing industry to press fruit, grapes, cheese, etc.



We can make a shape and dimension in compliance with customer's needs with respect to the operation of a given particular bag.

### Insulating bags

Insulating bags for oil transformers are used to equalize pressure in transformer oil tanks and protect the used oil from atmospheric humidity.



We can make various shapes and sizes of insulating bags in compliance with customer's needs.

### Connectors, sleeves and hoppers

We offer rubber or rubber-textile products mostly hand built and freely vulcanized in the autoclave of maximum diameter 2.8 m and 13 m long. These are for example silicon connectors and dust covers for nuclear power stations.



We produce products of atypical dimensions and shape in compliance with customer's needs for various fields of human activities.



# FUEL AND WATER STORAGE



**Rubena**

THE POWER OF FLEXIBILITY





# Creating complete flexible containment solutions



Rubena has a long and proud heritage in the design, development and of products, widely used in the harshest environments and in the most demanding applications.

Our policy of continuous improvement and investment in R&D ensures that all Rubena products are state of the art for reliability, long and trouble-free life.

Rubena accesses a broad range of technical expertise including raw materials. By working closely with our customers from initial feasibility through to design, manufacture and installation, we ensure project delivery to the agreed specification and often, by providing expertise, below expected cost.

Rubena serves a wide range of markets including the defence, maritime, petrochemical, power, security, agriculture and offshore industries.

We work across various technologically advanced industries to produce polymer and polymer-coated fabrics globally for applications including fluid handling, anti-vibration, moulded components, large industrial seals and power transmission belts. By developing the optimum solution for your application, we go further to engineer your solution.

Our experienced team coordinate closely with our customer's technical team to provide guidance and support

throughout the process to provide a highly personal service.

Our Technical Centre of Excellence and support team are based in Greater Manchester in the UK, with manufacturing based in the Czech Republic. Our state-of-the-art manufacturing facility, which houses some of the largest fabrication machinery in the world, is renowned for producing, dam membranes, with life cycles often in excess of 20 years.







## Product overview

Critical to the success of international military and humanitarian operations is the mobilisation of large quantities of fuel and water. Rubena provides a range of easily transported and rapidly deployable liquid storage solutions for use in the most extreme environments. Rubena flexible tanks are a standard, internationally recognised product used by both military and humanitarian organisations for the temporary storage and distribution of fuel and water.

They are available from 1,000 litres to 800,000 litres and supplied in a variety of material to suit the application.

The collapsible tanks are quick to deploy and can be stored using a minimum of space, ideal for environments where it can be difficult to establish more permanent solution such as steel tanks. One of the most challenging problems for fuel and water storage is the harsh environments where conflicts or relief operations may be conducted. Rubena flexible tanks have been successfully deployed from Arctic/Antarctic to tropical and desert conditions.

These flexible tanks are manufactured from specially developed rubber-coated textiles which are specifically designed to offer high abrasion and tear resistance. Each product will be designed for the specific duty required including all types of fuels, liquid fertiliser and water. Rubena also offers a broad range of chemical-resistant flexible tanks. The units can withstand extremes of temperature and almost any environment.

# Features & Benefits

- Durable and able to withstand harsh conditions.
- Manufactured from high-quality materials.
- Flexible and easily deployed.
- Built to an internationally recognised military standard.
- Available in a wide range of specifications.



## **Strong and reliable under harsh conditions**

Rubena flexible tanks have been designed to offer high abrasion, UV and fuel resistance. They are able to withstand extremes of temperature.

The units are constructed from high strength woven fabrics coated with high quality specially engineered compounds, providing a strong and durable liquid container. The materials have been designed to have high tensile strength with excellent tear and puncture resistance.

## **Flexible and easily deployed in any environment**

Where there is need for temporary liquid storage flexible tanks can be deployed quickly and filled on site and are available with all accessories needed to receive and deliver the fuel or water to generators, vehicles and helicopters, etc. Once the application is complete they can be emptied, cleaned and stored for future use.

The flexible nature of the tanks allows large quantities of water to be stored and distributed safely.

## **Available in a range of specifications depending on requirements**

Ranging in capacities from 1,000 up to 800,000 litres, Rubena flexible tanks are supplied in different material specifications depending on storage requirements and contained fluids such as fuel or water. Rubena can also supply pumps, filter systems, pipework and connections. Rubena also provides other products for use alongside flexible tanks including bund liners, ground sheets and UV covers. Bund liners used in conjunction with flexible tanks provide a reliable secondary containment around tanks to prevent fuel spillage with excellent tear and puncture resistance.



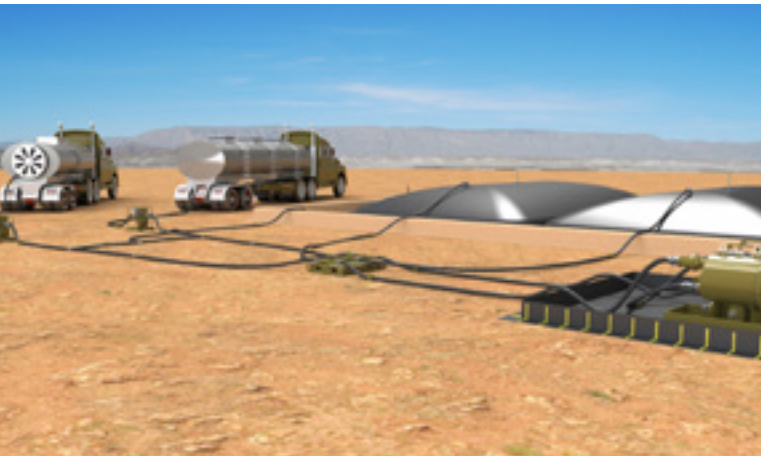

# Applications

Rubena flexible tanks have been in use in military and NATO-led missions as well as humanitarian operations around the world. Used in theatres of operations such as Iraq and Afghanistan, these units are able to meet the challenge of providing fuel and water storage solutions in harsh

environments that are difficult to access and where temperatures and dust are a major problem. Manufactured to internationally recognised military specifications, Rubena flexible tanks are critical to the success of military bulk fuel distribution networks.

Rubena flexible tanks provide a wide range of flexible liquid storage and distribution applications and are an essential component to military and relief operations worldwide.

# General description

## Heavy duty rubber

For the demanding requirements of the military environment specifically designed to meet British defence specification DGFLS279 with an operational life of 15 years.

## Standard rubber

A lighter weight fabric design to store distillate fuel oils with up to 40% aromatic content, with an operational life of 5-7 years.

Capacity (litres)	Length (m)	Width (m)	Filled height (m)
5 000	4.30	2.60	0.70
10 000	5.10	3.45	0.80
25 000	7.55	4.33	1.10
50 000	8.50	6.06	1.40
100 000	11.70	7.79	1.50
200 000	19.80	7.79	1.50

Sizes vary depending on materials and applications, above sizes are for guidance only. All other sizes, including bespoke dimensions, are available.

Most tanks are made to order; we have a standard range and can tailor sizes and accessories to meet with your specific requirements. We can manufacture tanks up to 800,000 litre capacity. Flexible tanks having a capacity of more than 200,000 litres can require non-standard fittings. Please contact our sales and technical team to discuss your job specific requirements to ensure you get the best possible service from your tank.

## Accessories

- Pumps
- Filter systems
- Pipework
- Connections



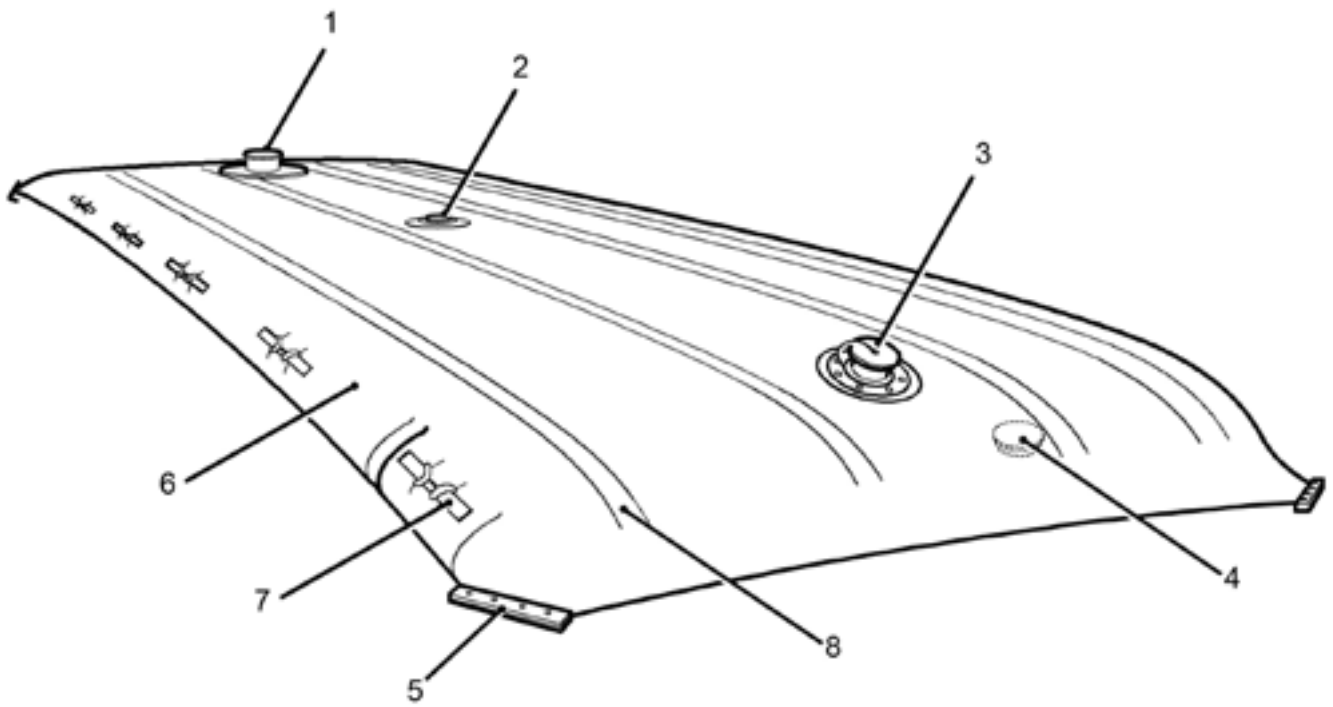

- 1 Outlet connection - oval
- 2 Combined vent & dip connection
- 3 Inlet connection - round
- 4 Drain connection - under at each end

- 5 Corner clamp joint
- 6 Fabric tank
- 7 Handle
- 8 Seam

## Typical assembly

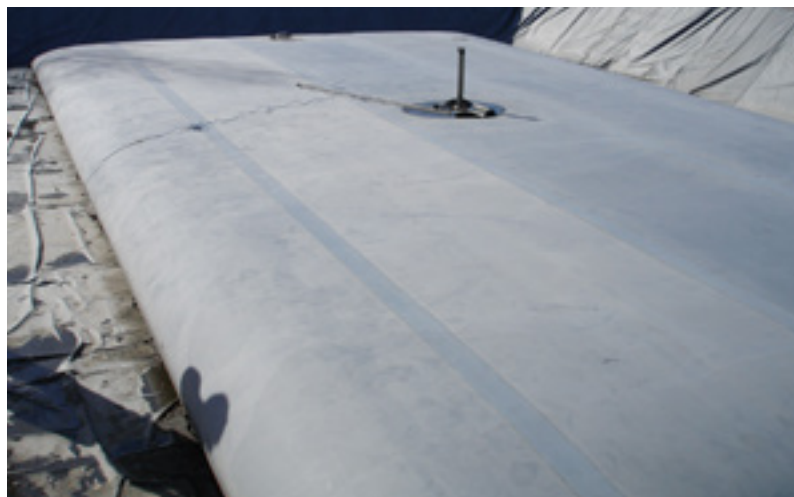



# DRY STORAGE SYSTEM



**Rubena**

THE POWER OF FLEXIBILITY



# Dry Storage System



The Rubena Dry Storage System can be used to protect a multitude of high value assets including military hardware, ammunition, emergency equipment such as generators, pumps and compressors, medical equipment and just about any high value asset that may be used occasionally.

This enables assets to be decentralised and stored where they will be required resulting in rapid deployment when needed.

The system has been proven in arctic, desert, dry and humid ambient conditions. NATO standard camouflage netting can also be incorporated.

Each Dry Storage System unit is supplied with a base and sealing rail, an inflatable sealing tube, a two-ply butyl cover, protection material, inflation and vacuum connections, desiccant bags to remove any remaining moisture and sensors to connect a hand-held portable hygrometer. Depending upon the application, wooden or polymer flooring will be included to absorb the static weight of the asset being protected. The base is inserted inside the sealing frame and the flooring is positioned onto the base.

The asset is positioned onto the base and the two-ply butyl cover is positioned over the asset, usually with some additional material to protect the asset, with desiccant bags positioned inside the cover. The humidity sensor(s) is supplied with a length of cable so that the sensor can be placed inside the cover to suit the application. The cover is then inserted inside the sealing rail, the inflatable seal is inserted into the rail and inflated, which then provides a seal between the base and the cover.

Air is then vacuumed out of the unit to remove humidity inside the Dry Storage System. This significantly reduces relative humidity, and the effect of oxidation is eliminated thereby protecting the asset for long periods of time.

Maintenance is limited to periodic visual checks and humidity readings to ensure the Dry Storage System is holding the vacuum. Inadvertent damage to the unit can be repaired on-site very easily and a repair kit is supplied with each unit.

Other optional accessories include a hand-held hygrometer, compressor/vacuum pump and associated hoses, spare desiccant bags supplied in a sealed package and a specific packing crate to store the system when not in use.

Installation is simple and quick utilising a minimum of labour and once the asset is installed inside the Dry Storage System, it is protected against atmospheric degradation for long periods thereby extending the asset's expected life.

The system has a design life in excess of 20 years and can be used over and over again leading to a versatile, durable and robust protection system.



*Sectional view of seal and sealing frame with base sheet and cover in position*

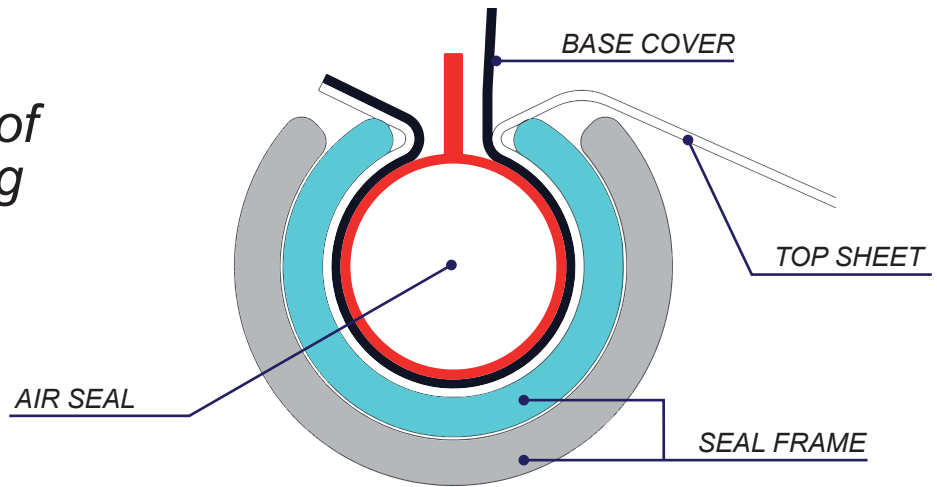

## Advantages

- Significantly prolongs the life of the stored asset and thereby offers a very short return on investment.
- Asset is available for almost immediate use when removed from the Dry Storage System.
- Assets can be decentralised and stored where they are likely to be needed.
- Designed for long life using best available materials of construction designed for -40 °C to +120 °C and with high UV and Ozone protection.
- Suitable for almost any location and eliminates the need for expensive climate-controlled buildings.
- Easily rigged and derigged using minimum amount of labour.
- Can be reused many times and for a variety of assets.
- Extremely low maintenance and site repairable.
- Minimum site tooling required so can be utilised in very remote locations.





# LOW PRESSURE PNEUMATIC FENDERS



***Rubena***

THE POWER OF FLEXIBILITY

# Low Pressure Fenders

Rubena has a long and proud heritage in the design, development and manufacture of polymer coated fabric products. For decades we have been producing an extensive range of products, widely used in the harshest environments and in the most demanding applications. Our policy of continuous improvement and investment in R&D ensures that all Rubena products are state of the art for reliability, long and trouble-free life.

Rubena accesses a broad range of technical expertise including raw materials. By working closely with our customers from initial feasibility through to design, manufacture and installation, we ensure project delivery to the agreed specification and often, by providing expertise, below expected cost.

Rubena serves a wide range of markets including the defence, maritime, petrochemical, power, security, agriculture and offshore industries.

Our business area works across technologically advanced industries to produce polymer and polymer-coated fabrics globally for applications including fluid handling, anti-vibration and moulded components. By developing the optimum solution for your application, we go further to engineer to engineer your solution.

Our experienced team coordinate closely with our customer's technical team to provide guidance and support

throughout the process to provide a highly personal service. Our Technical Centre of Excellence and support team are based in Greater Manchester in the UK, with manufacturing based in the Czech Republic.

Our state-of-the-art manufacturing facility, which houses some of the largest fabrication machinery worldwide, is renowned for producing, dam membranes, with life cycles often in excess of 20 years.







## Product overview

Rubena low-pressure (LP) pneumatic fenders play an essential role in the safe berthing of ships at sea in emergency or other operations such as refuelling.

Unlike other fenders, Rubena LP fenders are designed to spread berthing forces over a large area, achieving a far lower load reaction and hull pressure than any other fender system. This makes them ideal for use when berthing vessels with single, non-metallic or weakened hulls.

While durable enough to stand up to the most hostile environments at sea, the LP fenders are considerably lighter than a high-pressure fender of equivalent performance, and can easily be transported, inflated at point of use and deployed in a range of emergency applications.

This reduces deck space to an absolute minimum compared with alternative fender types. They are also easy to deflate and store for later use which significantly reduces UV light and Ozone damage resulting in extremely long service life.

It is not unusual for Rubena fenders to still be in use 25 years after first delivery. Available in a range of standard sizes, they can also be custom made to a specific requirement. Rubena has been supplying LP pneumatic fenders to the maritime industry for decades.

# Features & Benefits

- Spreads berthing forces over the full length of the fender as opposed to a point-contact resulting in very low hull pressures to reduce the risk of hull damage.
- Effectively and safely absorbs the kinetic energy of the moving vessel during the berthing operation.
- Lowest load reactions of any alternative fender system.
- ISO17357-2:2014 compliant with tests witnessed and reviewed by American Bureau of Shipping.
- Ideal for use with single hull, non-metallic or weakened vessels or those with sensitive electronic systems requiring protection when berthing. Unlikely to damage vessels during unintended collisions.
- Light weight and low package size make the Rubena fenders particularly suitable for coast guard and rescue vessels where fender requirements may not be known in advance.
- No special davits required and can be quickly and safely deployed at point of use.



## Transportation

LP Fenders can easily be carried, inflated and deployed in a range of emergency applications via air, sea or land. This flexibility makes them particularly suited for ship-to-ship operations and offer a significant impact on time and costs of transport. As they can be transported and deployed quickly, the Rubena fenders are key to preventing oil spill from damaged vessels, thereby minimising damage to the environment.

## Storage

Easy to deflate and store for later use. When deflated they can be rolled into small, lightweight packages and are therefore very cost effective by increasing deck space and reducing storage weight. As they operate at a nominal pressure of 70 mbar (1 Psi), any convenient air supply can be used for inflation. Their low inflation pressure also makes repairs and maintenance easy and safe.

## Improved design

Durable and unencumbered by external fittings, the units can be towed while inflated and attachments suitable for towing and mooring can be provided at each end of the fender to provide flexibility of deployment. In addition, girthing ropes are fitted for ease of handling and manoeuvring using standard ship mechanical handling gear.



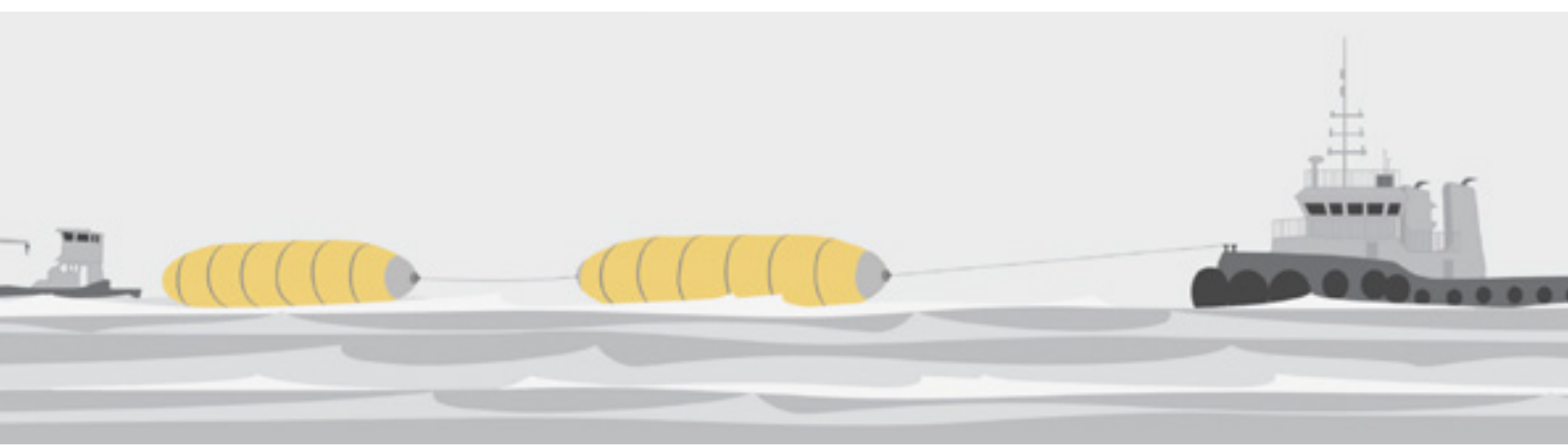
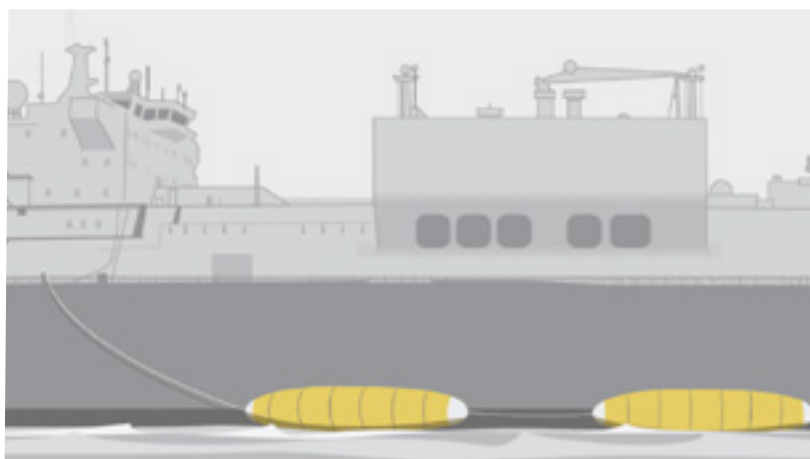

# Applications

A high-energy absorbing capacity coupled with ease of handling enables ships of even the largest tonnage to be safely fendered in various conditions and berthing operations. Rubena LP pneumatic fenders have been in operation worldwide in many applications, both military and commercially, for many years.

These include ship to ship transfer and refueling/replenishment at sea, offshore mooring, naval applications, salvage and cargo recovery, rescue and emergency floatation. They are extensively used for military operations at sea including mine sweeping. Many commercial companies specialising in salvage and emergency choose

Rubena fenders to reduce risk and lower their operating costs. They feature in the operations of international salvage companies who specialise in providing a quick response to marine emergencies around the globe and by specialist shipbuilders.

# General description

<b>Unit specification</b>	Manufactured in diameters from 1.0 m to 4.5 m; lengths of tenders can be made to customer requirements and in accordance with ISO 17357-2:2014 (E).
<b>Materials and construction</b>	Constructed from a woven high tenacity, continuous filament nylon-based fabric, coated on both sides with an abrasion resistant synthetic rubber compound. Individual sections are constructed such that they are of strength equivalent to the base material or fabric.
<b>Load reaction</b>	The maximum specific load reaction pressure that can be developed from a LP fender occurs at at 60% compression and is 11 tonnes per m <sup>2</sup> .
<b>Energy absorption</b>	Dependent on the size of the fender.
<b>Inflation and deflation</b>	Units operate at a nominal pressure of 70mbar (1 Psi). Any convenient air supply, compressor or blower can be used for inflation.

## Accessories

- Blower unit
- Medium duty delivery and suction hose Inflation adaptor
- Transportation/storage case repair kits
- Pressure gauge assembly lifting slings
- Cargo nets

Nominal size (m)		Nominal weight (kg)	Approx. folded size (m) Length x Width x Height	Fender end construction (typical)
Diameter	Length			
1.0	5.0	90	1.5 x 0.8 x 0.7	Parcel End
1.0	6.0	110	1.5 x 0.9 x 0.7	
1.0	8.0	140	1.5 x 0.9 x 0.8	
1.5	4.0	110	1.6 x 0.8 x 0.7	
1.5	5.0	135	1.6 x 0.9 x 0.8	
1.5	6.0	160	1.6 x 1.0 x 0.9	
1.5	8.0	210	1.6 x 1.0 x 1.0	
1.8	6.0	210	1.8 x 1.0 x 0.9	Clomped End
1.8	8.0	270	1.8 x 1.0 x 1.0	
1.8	10.0	330	1.8 x 1.2 x 1.1	
1.8	12.0	390	1.8 x 1.2 x 1.2	
2.3	8.0	360	2.0 x 1.0 x 1.0	
2.3	10.0	440	2.0 x 1.2 x 1.0	
2.3	12.0	520	2.0 x 1.2 x 1.2	
2.3	16.0	680	2.0 x 1.4 x 1.3	Moulded End
2.75	10.0	600	3.8 x 1.3 x 1.25	
2.75	14.0	800	3.8 x 1.45 x 1.35	
2.75	18.0	1200	3.8 x 1.6 x 1.4	
2.75	22.0	1600	3.8 x 1.7 x 1.55	
3.2	12.0	800	3.8 x 1.4 x 1.3	
3.2	16.0	1040	3.8 x 1.5 x 1.4	
3.2	20.0	1280	3.8 x 1.65 x 1.5	
3.2	24.0	1520	3.8 x 1.75 x 1.6	
4.5	18.0	1600	3.8 x 1.6 x 1.45	
4.5	22.0	2000	3.8 x 1.7 x 1.6	
4.5	26.0	2400	3.8 x 1.8 x 1.75	
4.5	30.0	2800	3.8 x 1.9 x 1.9	



# Features & Benefits

Rubena low pressure fenders have also undergone third party type approval testing based on the requirements of ISO 17357-2:2014. These tests included parallel plate compression, compression recovery, angular compression and durability testing. The results of these tests confirmed previous test data and theoretical performance ratings and were witnessed, reviewed and endorsed by the American Bureau of Shipping. Further details of the testing procedures and the results can be provided on request.

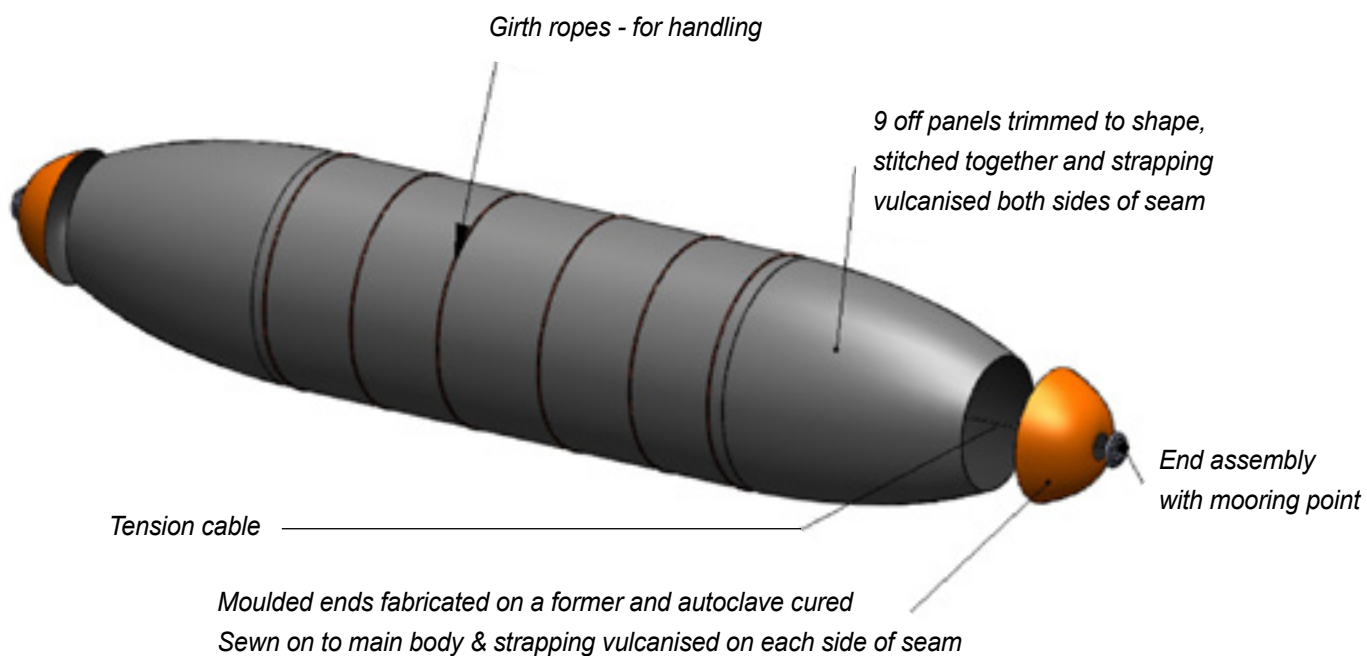

**Rubena**

# Dracone Barge





# Dracone barge



Rubena has a long and proud heritage in the design, development and manufacture of polymer coated fabric products. For decades we have been producing an extensive range of products, widely used in the harshest environments and in the most demanding applications. Our policy of continuous improvement and investment in R&D ensures that all Rubena products are state of the art for reliability, long and trouble free life.

Rubena accesses a broad range of technical expertise within our company including raw materials. By working closely with our customers from initial feasibility through to design, manufacture and installation, we ensure project delivery to the agreed specification and often, by providing expertise, below expected cost. Our experienced team coordinate closely with our customer's technical team to provide guidance and support throughout the process to provide a highly personal service.

Our Technical Centre of Excellence and support team are based in Greater Manchester in the UK, with manufacturing based in the Czech Republic. Our state of the art manufacturing facility, which houses some of the largest fabrication machinery in the world, is renowned for producing dam membranes, with life cycles often in excess of 20 years. Rubena serves a wide range of markets including the defence, maritime, petrochemical, power, security, agriculture and offshore industries.

Rubena works across technologically advanced industries to produce polymer and polymer-coated fabrics globally for applications including Fluid handling, anti-vibration, moulded components, pipe seals and sealing profiles. By developing the optimum solution for your application we go further to engineer your solution.





## PRODUCT OVERVIEW

## DRACONE BARGE

The Dracone barge has been used to transport large volumes of liquids at sea for decades and is time-proven. They have been in use with many military organisations for fuel transfer from sea to shore, coastguards for oil spill collection and removal of black and grey water. Many oil companies use the Dracone Barge as an essential part of their oil spill response equipment. Available in a range of sizes up to 1,000,000 litres, the Dracone barge is a flexible, towable bladder constructed from high-performance materials enabling it to withstand hostile ocean conditions.

The Dracone barge was originally developed at Cambridge University in the 1950's during the Suez oil crises in order to transport fuel from the Persian Gulf. Since then, this unique, versatile, durable and highly reliable product has had an unrivalled record of operational performance worldwide. Dracone barges continue to operate globally, providing a unique system of bulk liquid transport and oil spill collection and removal in a range of applications and industries.

Originally used for military purposes for the bulk transportation of refined fuels, they have many other commercial and military applications

The Dracone barges are in service with, amongst many others, the UK Ministry of Defence, the United States and Indian Coast Guards, the US Navy, the Australian Ministry of Defence and almost all oil companies own them. In military operations, they are primarily used to transfer bulk volumes of fuel from a ship to the shore. The Dracone barge is simple to operate, which allows it to be repeatedly ferried to and from an oil spill containment area.



# FEATURES & BENEFITS

## DRACONE BARGE

### Dracone barges

- Versatile large capacity for transportation and storage of liquids
- Durable and able to withstand harsh conditions
- Suitable for fuels, oil spill collection, grey and black water
- Easily towed in open water
- Quickly deployed and air transportable
- Very long life expectancy - >20 years



**Strong and reliable under harsh conditions** - The Dracone barge is constructed from synthetic rubber-coated nylon fabric, making it highly resistant to all weather conditions, abrasion, sunlight, oil and sea water.

The construction of the nose and tail moldings, based on modern composite technology and extensively tested under stress analysis, is essential to the overall strength of the unit. For use in pollution control, the inside has a nitrile coating that is specially designed to store distillate fuel oils of up to 30 % aromatic content.

**Easily towed in open water** - With non-inflatable buoyancy panels, the Dracone barge will float whether empty or full and will follow the exact course of the towing vessel, allowing tight maneuvers to be executed. Designed for towing in open seas, the unit has undergone intensive stress analysis to determine the optimal design for maximum stability in water.

**Rapidly deployable and adaptable** with a large capacity and 'fold away' flexibility the Dracone barge is an essential part of the oil spill first response kit. Easy to set up and quick to launch from a quayside, the deck of an offshore vessel, or drop launched by crane or helicopter with minimal lifting equipment, it can be quickly transported to critical areas, filled to an enormous capacity to limit oil spill movements, and then easily towed for safe disposal.

**Other products** - Alongside the Dracone barge, Trelleborg also provide other essential products for pollution control:

- **Flexible pillow tanks** - Primarily for use on land for the temporary storage of large quantities of fuels, water and crude oil, flexible tanks can be manufactured to specified sizes to fit available space on oil spill collection ships. The tanks are easily filled and once emptied can be folded or stored away.
- **Bund liners** - Used in conjunction with flexible tanks they provide a reliable containment around the tanks to prevent fuel spillage.

# GENERAL DESCRIPTION

DRACONE BARGE

<b>UNIT SPECIFICATION</b>	Available in a range of sizes and capacities, but can also be custom made to fulfil a specific client need. General specifications are shown below.
<b>MATERIALS AND CONSTRUCTION</b>	Constructed from high-tenacity woven nylon fabric coated with polychloroprene. Interior coated with nitrile rubber for transporting distillate fuel oils of up to 30% aromatic content. Nose and tail mouldings constructed based on modern composite technology using rubber encapsulated nylon cord.
<b>CONNECTIONS</b>	Fill/discharge hoses can be offered to suit customer requirements. Standard connections include 4" or 6" (100 m or 150 mm) but it is possible to modify hardware to suit.
<b>TOWING</b>	Depending on size can be safely towed at 6 - 10 knots in moderate seas.

## Accessories

- Towing hose
- Recovery bend
- Cargo net
- Navigation marker
- Quick release hook
- Towing rope
- Nosecone pump

		DRACONE TYPE								
		A1	A2	D5	D10	E	F	J	L	O
<b>100% CAPACITY</b>	m <sup>3</sup>	4.55	9.1	22.75	45.50	100.00	191.00	385.00	519.00	1100.00
<b>85% CAPACITY</b>	m <sup>3</sup>	3.90	7.80	45.50	38.60	85.00	162.00	327.25	441.00	935.00
<b>LENGTH</b>	m	8.58	14.17	15.95	31.45	38.45	50.45	66.00	66.00	91.45
<b>DIAMETER</b>	m	0.94	0.94	1.42	1.42	1.87	2.35	2.82	3.28	4.23
<b>EMPTY WEIGHT</b>	kg	270	310	430	780	1000	2275	3540	4060	6500

## LAYOUT OF A DRACONE

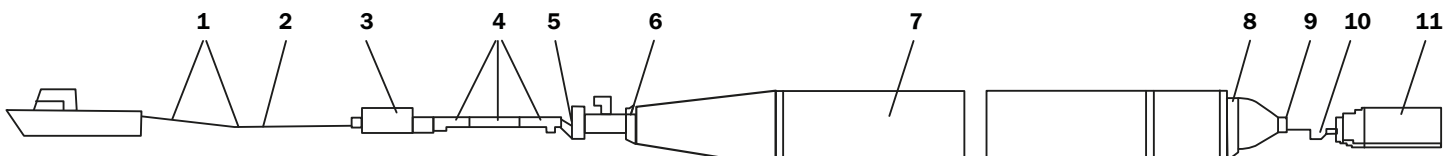

## Accessories

- 1 Main towing ropes
- 2 Towing pendant
- 3 Recovery bend
- 4 Towing hose
- 5 Nose cone
- 6 Mooring ring
- 7 Dracone barge
- 8 Stabiliser
- 9 Mooring ring
- 10 Tow line
- 11 Light float with navigation light



***Rubena***

# Port Security Barriers



# Port security barriers

**Rubena has a long and proud heritage in the design, development and manufacture of polymer coated fabric products. For decades we have been producing an extensive range of products, widely used in the harshest environments and in the most demanding applications. Our policy of continuous improvement and investment in R&D ensures that all Rubena products are state of the art for reliability, long and trouble free life.**

Rubena accesses a broad range of technical expertise including raw materials. By working closely with our customers from initial feasibility through to design, manufacture and installation, we ensure project delivery to the agreed specification and often, by providing expertise, below expected cost.

Our experienced team coordinate closely with our customer's technical team to provide guidance and support throughout the process to provide a highly personal service. Our Technical Centre of Excellence and support team are based in Greater Manchester in the UK, with manufacturing based in the Czech Republic. Our state of the art manufacturing facility, which houses some of the largest fabrication machinery in the world, is renowned for producing dam membranes, with life cycles often in excess of 20 years.

Rubena serves a wide range of markets including the defence, maritime, petrochemical, power, security, agriculture and offshore industries. Rubena Industrial Solutions business area works across technologically advanced industries to produce polymer and polymer-coated fabrics globally for applications including fluid handling, anti-vibration, moulded components, pipe seals and sealing profiles. By developing the optimum solution for your application we go further to engineer to engineer your solution.







## PRODUCT OVERVIEW

Trelleborg port security barriers provide a proven, durable and cost effective solution against seaborne threats whether deliberate or accidental. They are available from 1.4 m to 2.4 m diameter, in individual standard lengths of 25 m or can custom made. They are interconnected using marine grade shackles, quick release catches and/or closure plates to form almost any barrier length and configuration required. Our inflatable barriers are manufactured from a purpose-built rubber coated fabric, which incorporates high levels of protection against abrasion, tear, UV and Ozone resulting in a design life expectancy in excess of 20 years.

These barriers have been installed to effectively safeguard some of the most sensitive global naval bases, high value shipping and petrochemical ports. Their low draft ensures that gateway systems are operated quickly and conveniently. The Trelleborg port security barriers require very little service and maintenance attention and provide continuity and integrity of protection throughout the life of the barrier. This results in the lowest through-life costs of any equivalent port protection barrier. As the main body is made of rubber coated fabric, there are few metal components which reduces maintenance and replacement costs even further. The barriers are sensitive to the environment and, whilst alternative systems can cause extensive risks, the Trelleborg port security barriers will not harm local marine life or ecology.

## PORT SECURITY BARRIERS

Each barrier system is unique and will have different local challenges. The Trelleborg technical team has decades of experience and provides a full design and consultancy service from initial concept through to installation. Mooring buoys and slide rails used to connect the individual barriers are manufactured by Trelleborg, our parent company, which results in single source responsibility and access to full technical expertise. Mooring buoy anchoring will be dependent upon local conditions but can include self-propelled anchors, drag anchors and concrete dead weights. Installation can be provided by Trelleborg using dedicated expertise or we can provide full supervision of local contractors.

# FEATURES & BENEFITS

## PORT SECURITY BARRIERS

- Minimum maintenance resulting in lowest cost of ownership.
- Rugged and durable to provide high levels of barrier system integrity.
- Imposing and highly visual deterrent.
- Tested and proven to repel determined attacks whilst causing minimal damage during accidental collisions.
- Easily installed, flexibility in configuration and suitable for seasonal deployment.
- Low draft reduces marine growth, allows simple operation of gateways and provides maximum barrier height.
- Standard diameters of 1.4, 1.8 and 2.4 m and adaptable for protection of pipelines and fixed assets from accidental collisions.



### Designed for high impact

The primary function is to prevent or delay an attacking vessel entering restricted area thereby providing time for secondary security measures to be deployed. Inherently flexible, the portable units are lightweight and easy to inflate or deflate and transport. This design makes them highly versatile with set lengths easily coupled together to configure to many different port layouts, providing a distinct advantage over heavier fixed or fencing based barrier systems that require more complex and costly operations to transport and install.

Easily maneuvered in water, they are shackled together using standard buoys and anchor systems at predetermined intervals and can be linked in any configuration and practically any length. A series of units operates as a simple gate system to provide authorized access into and out of the secured zone. The space between connecting buoys is dependent on geography, climate and tides and is adaptable to virtually any naval or commercial port location.

### Key safety features

- Operates at low pressure for safety.
- No danger of catastrophic deflation or sudden release of stored energy if accidentally punctured.
- An individual barrier will slowly deflate to 50% of its diameter to enable the barrier system maintains its integrity.
- Resistant to small arms fire.
- The rubber body construction will not damage passing vessels which may accidentally contact the barrier.
- The barrier 'softness' will cause no harm to public or their craft hitting the barrier by accident.
- Ecologically sensitive and will not harm marine life.



# APPLICATIONS

## PORT SECURITY BARRIERS



**Rubena port security barriers are protecting high value marine assets in many ports globally.**

Whilst suitable for any port, the rubber coated fabric construction makes them the preferred choice for submarine bases or where there is a high level of public and commercial traffic.

As they are easily and quickly inflated and deflated, they can be used for seasonal deployment or when security threat levels are elevated.



A simple, lower cost demarcation barrier of 0.5 or 1 m diameter is available where port vessel movement control is required such as around piers and pipeline jetties.

With an unrivalled versatility in design and installation, the barriers can easily be adapted to any port situation, naval or commercial in addition to the protection of sensitive land-based assets that may be vulnerable to sea attack, such as coastal power plants, desalination plants and petrochemical installations.

They can be used to provide temporary or short term protection for visiting dignitaries or high value military assets in repair shipyards. The port security barriers have been deployed in numerous Olympic Games venues.

In addition to their extensive use at military sites, The **Rubena** port security barrier has been adapted to provide protection of fixed assets such as fuel pipeline.

For example, 2 barriers are installed at Changi airport to protect the main fuel lines jetty from accidental collision by the first response.

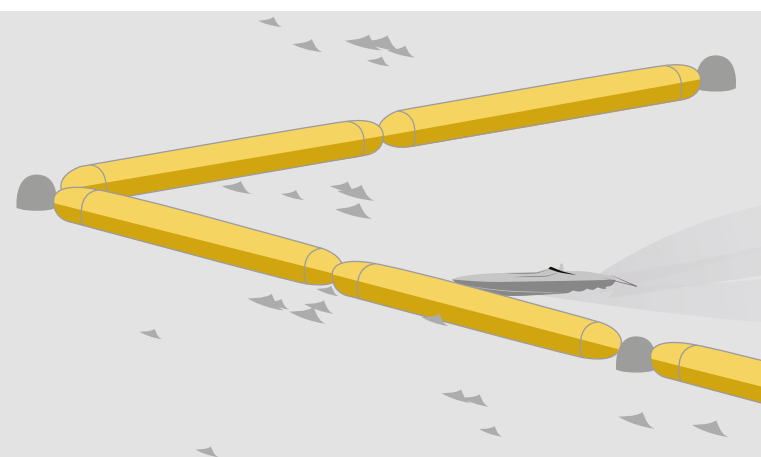

# GENERAL DESCRIPTION

## PORT SECURITY BARRIERS

<b>UNIT SPECIFICATION</b>	Manufactured in various sizes typically in 25 m lengths and 2.3 m diameter. Operating with an initial internal pressure of 1Psi.
<b>INSTALLATION</b>	Trelleborg Flexible Containment Solutions have a partner company which specialise in the installation and continual maintenance of our barrier systems.
<b>INFLATION &amp; DEFLATION</b>	Shackled together with buoys and anchor systems, design dependent on environmental conditions and threat levels.
<b>CONNECTION &amp; MOORING</b>	Optional connectors between barriers include specific closure plates, marine shackles or quick release connectors. Buoys, anchor systems and pilings are designed to suit local conditions.
<b>TESTING</b>	Barriers have been tested against multiple shots from small hand guns 50 calibre, 7.63 and 5.56 NATO. The worst penetration was a 4 mm hole left by 0.375 magnum, other rounds just separated the fabric and closed back over.

### Accessories

- A range of sonar, radar and camera equipment can be installed to provide a complete security package.
- Dive nets and anti-debris nets easily incorporated.
- Marine solar navigation warning lights.
- Reflexive strips.
- Tamper alarms at connectors.

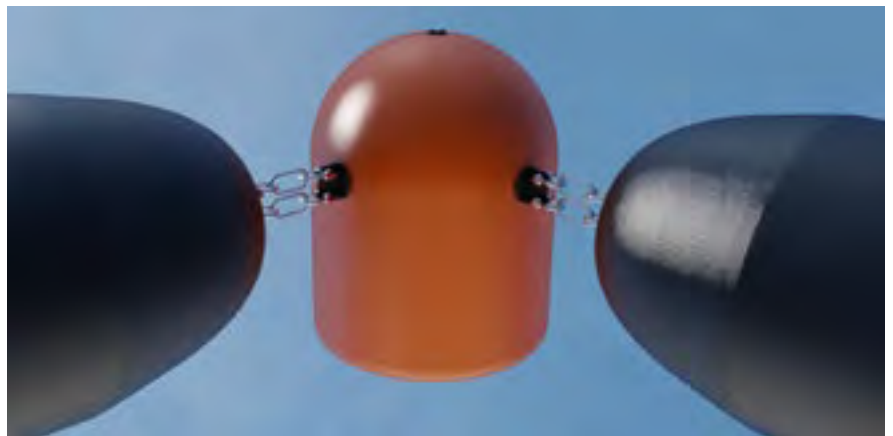
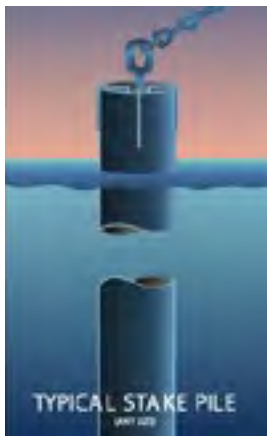



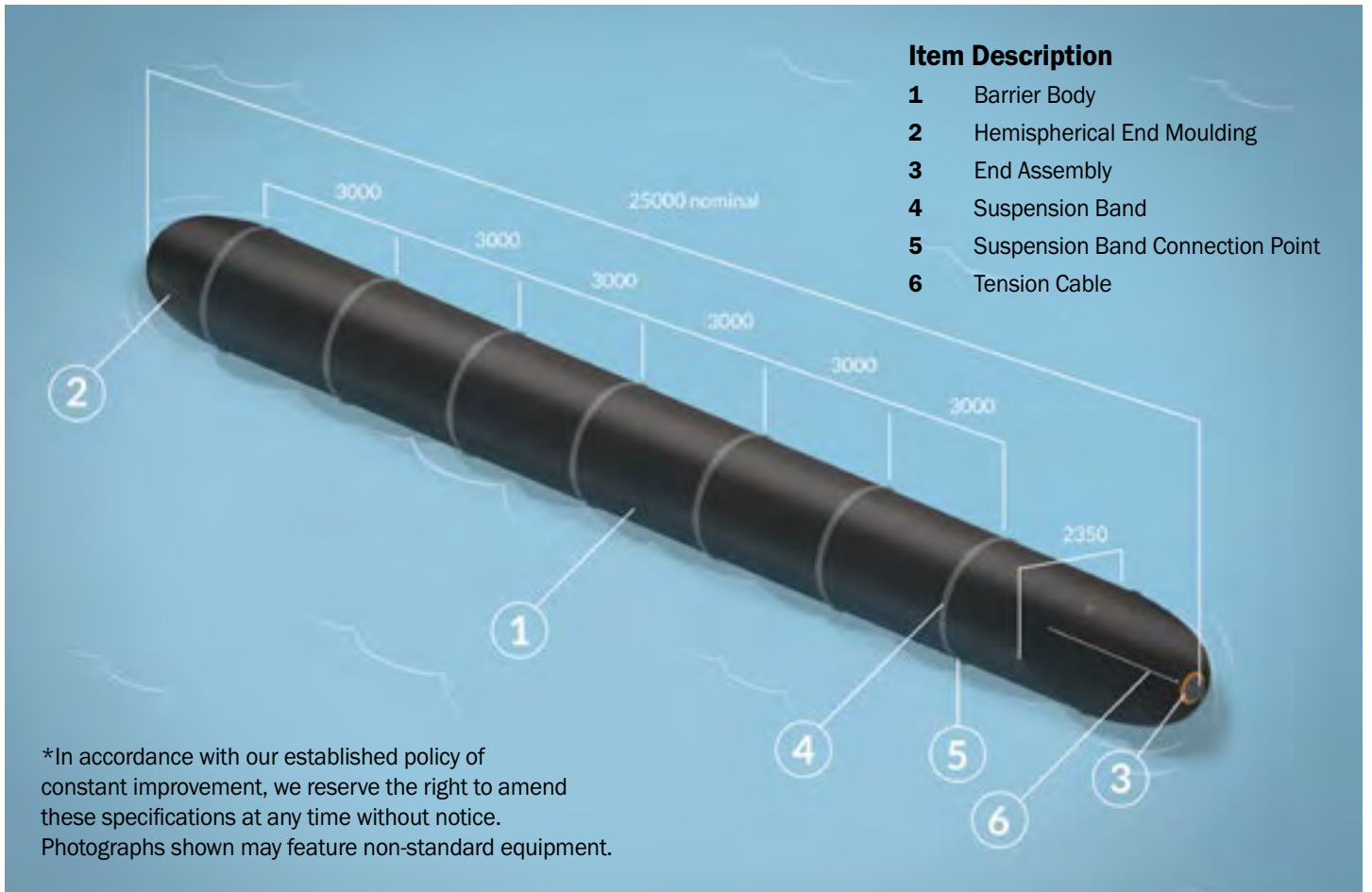

# Marine Exclusion Barrier Systems



**Rubena Inflatable Exclusion Barrier Systems are rapidly gaining acceptance as the preferred solution for protecting sensitive areas in river waterways, ports, harbours and marinas in addition to military and commercial docks. Easily deployed, the Rubena Exclusion Barrier Systems provide highly visible exclusion perimeters around valuable or sensitive assets to ensure traffic is isolated from the exclusion zone.**

Designed for a long life, the barrier has a low operating pressure and the robust design ensures that vessels will not be damaged during accidental collision whilst not compromising the exclusion perimeter. They can be adapted to provide protection for piers or jetties and water intake zones for desalination, power plants and oil and gas installations. Trelleborg is a global leader in marine systems and, uniquely, the raw material, barriers and mooring buoys are all manufactured by the company ensuring that Rubena

Inflatable Exclusion Barrier System is manufactured to the highest quality using the latest production techniques with single source responsibility. Rubena also manufactures a full range of anti-terrorist barriers from 1.4 m to 2.4 m diameter and, with a wealth of marine experience, we provide consultancy from design through to installation and commissioning to ensure your Exclusion Barrier System provides the precise and optimum solution required.

## ADVANTAGES

- Provides a clear and imposing deterrent from entry into a restricted area.
- Very cost-effective and extremely difficult to breach.
- Will not cause damage to vessels accidentally colliding with the barrier.
- Strong yet lightweight with a low internal pressure to ensure accidental impacts are absorbed without damaging the barrier.
- Manufactured from the highest quality polychloroprene coated fabric produced by Trelleborg with high abrasion, high tear strength, UV and Ozone protection for very long-life.
- Easily deployed and adaptable to almost any installation.
- Reduced storage space if the barrier is to be deployed seasonally.
- Mooring options available from Trelleborg including sliding rails, mooring buoys, piling etc.
- Rubena will provide full system design and support through to final installation.
- Extremely low maintenance and site-repairable.
- Options include reflective strips, warning signs, marine-standard warning lights and storage containers.



# LONG LASTING, HARD WEARING, WEATHER RESISTANT, DURABLE, PORTABLE, FLEXIBLE, SAFE

**Constructed from Rubena's own unique engineered time-proven, high tenacity, polychloroprene coated fabric the Trelleborg Exclusion Barrier system is highly durable and will stand the test of time.**

Available in diameters of 500 mm and 1000 mm and supplied in lengths up to 25 m. Linked together with a flexible, strong coupling, sections can be linked with others to create the custom length required whether it is utilised in open sea, harbour, jetties or piers and will provide a visible and imposing barrier which is extremely difficult to breach. Our specialist team can provide full system design advice and guidance to help you with a fully customised system, with a wide range of mooring options to suit your specific location as well as additional design features such as increased visibility, warning signs and standard marine warning lights.

The **Rubena** Exclusion Barriers system is inflatable and lightweight compared with alternative solutions so initial installation and redeployment are made significantly easier than larger traditional more cumbersome fixed systems. This feature is important if you make regular or seasonal changes to demarcation zones, the system can be deflated, removed, relocated and re-inflated elsewhere or stored when not in use. This very cost effective solution also offers an additional level of safety and protection to vessels which may accidentally collide with the barrier. Inflated to just 70 Mbar internal pressure the Trelleborg Exclusion Barrier system offers a very safe alternative to other solutions such as hard foam filled systems.



# ***Rubena***

**www.rubena.eu**

**ISO-14001**

**ISO-9001**

Rubena, s.r.o.  
Náchodská 449, 549 32 Velké Poříčí, Czech Republic  
Phone: +420 491 447 536  
E-mail: bags@rubena.cz